

MITSUBISHI ELECTRIC

Air-Conditioners

INDOOR UNIT

CE

PEH-RP8, 10MYA

FOR USER
FÜR BENUTZER
POUR L'UTILISATEUR
PARA EL USUARIO
PER L'UTENTE
VOOR DE GEBRUIKER

FÖR ANVÄNDAREN
TIL BRUGER
PARA O UTILIZADOR
ΓΙΑ ΤΟΝ ΧΡΗΣΤΗ
KULLANICI İÇİN
ДЛЯ ПОЛЬЗОВАТЕЛЯ

OPERATION MANUAL

For safe and correct use, please read this operation manual thoroughly before operating the air-conditioner unit.

BEDIENUNGSHANDBUCH

Zum sicheren und einwandfreien Gebrauch der Klimaanlage dieses Bedienungshandbuch vor Inbetriebnahme gründlich durchlesen.

MANUEL D'UTILISATION

Pour une utilisation correcte sans risques, veuillez lire le manuel d'utilisation en entier avant de vous servir du climatiseur.

MANUAL DE INSTRUCCIONES

Lea este manual de instrucciones hasta el final antes de poner en marcha la unidad de aire acondicionado para garantizar un uso seguro y correcto.

ISTRUZIONI DI FUNZIONAMENTO

Leggere attentamente questi istruzioni di funzionamento prima di avviare l'unità, per un uso corretto e sicuro della stessa.

BEDIENINGSHANDLEIDING

Voor een veilig en juist gebruik moet u deze bedieningshandleiding grondig doorlezen voordat u de airconditioner gebruikt.

DRIFTSMANUAL

Läs denna driftsmanual noga för säkert och korrekt bruk innan luftkonditioneringen används.

DRIFTSMANUAL

Læs venligst denne driftsmanual grundigt før aircondition anlægget betjenes af hensyn til sikker og korrekt brug.

MANUAL DE OPERAÇÃO

Para segurança e utilização correctas, leia atentamente o manual de operação antes de pôr a funcionar a unidade de ar condicionado.

ΕΓΧΕΙΡΙΔΙΟ ΟΔΗΓΙΩΝ ΧΡΗΣΕΩΣ

Για ασφάλεια και σωστή χρήση, παρακαλείσθε διαβάσετε προσεχτικά αυτό το εγχειρίδιο χρήσεως πριν θέσετε σε λειτουργία τη μονάδα κλιματισμού.

İŞLETME ELKİTABI

Emniyetli ve doğru biçimde nasıl kullanılacağını öğrenmek için lütfen klima cihazını işletmeden önce bu elkitabını dikkatle okuyunuz.

РУКОВОДСТВО ПО ЭКСПЛУАТАЦИИ

Для обеспечения правильного и безопасного использования следует ознакомиться с инструкциями, указанными в данном руководстве по эксплуатации, тщательным образом до того, как приступить к использованию кондиционера.

GB

D

F

E

I

NL

SW

DK

P

GR

TR

RU

 MITSUBISHI
ELECTRIC

2 [Fig. 2.0.1]

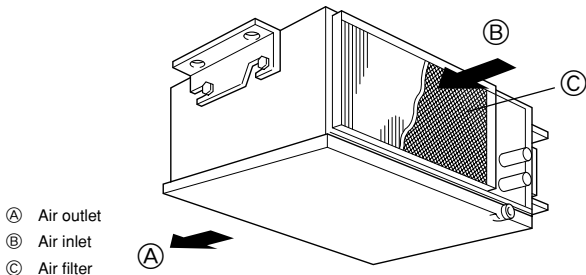

- (A) Air outlet
- (B) Air inlet
- (C) Air filter

[Fig. 2.0.2]

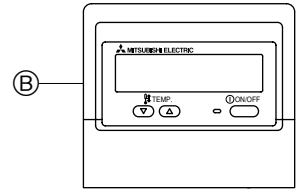
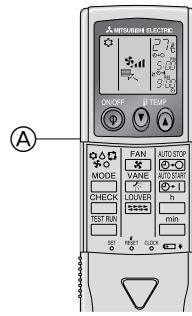

- (A) Wireless remote controller (option)
- (B) Remote controller

3 [Fig. 3.0.1]

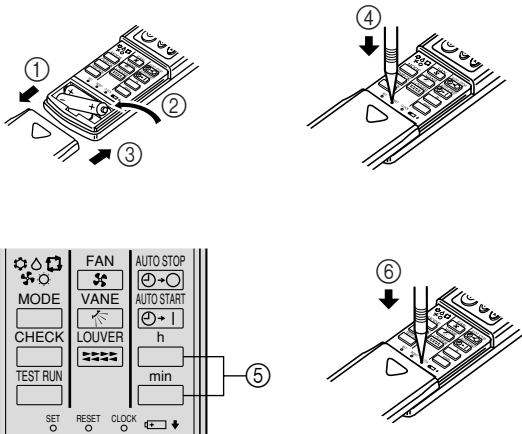

5 [Fig. 5.0.1]

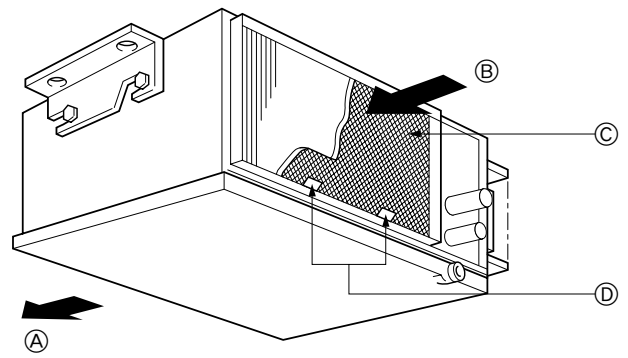

- (A) Air outlet
- (B) Air inlet
- (C) Air filter
- (D) Air filter handle

Contents

1. Safety precautions	3	3.5. Time setting	7
1.1. Installation	3	3.6. Timer setting	7
1.2. During operation	4	3.7. Others	8
1.3. Disposing of the unit	4	4. The smart way to use	8
2. Names and functions of various parts	4	5. Caring for the machine	8
3. Operation	5	6. Troubleshooting	9
3.1. ON/OFF	6	7. Troubleshooting [for wireless remote controller (option)]	9
3.2. Selecting operation	6	8. Installation and transferring works, and checking	10
3.3. Room temperature adjustment	7	9. Specifications	10
3.4. Fan speed adjustment	7		

1. Safety precautions

- ▶ Before operating the unit, make sure you read all the “Safety precautions”.
- ▶ “Safety precautions” lists important points about safety. Please be sure to follow them.

Symbols used in the text

Warning:

Describes precautions that should be observed to avoid the risk of injury or death to the user.

Caution:

Describes precautions that should be observed to prevent damage to the unit.

Symbols used in the illustrations

 : Indicates an action that must be avoided.

 : Indicates that important instructions must be followed.

 : Indicates a part which must be grounded.

 : Indicates that caution should be taken with rotating parts. (This symbol is displayed on the main unit label.) <Color: yellow>

 : Beware of electric shock. (This symbol is displayed on the main unit label.) <Color: yellow>

-  **Warning:**
Carefully read the labels affixed to the main unit.

1.1. Installation

- ▶ After you have read this manual, keep it and the Installation Manual in a safe place for easy reference whenever a question arises. If the unit is going to be operated by another person, make sure that this manual is given to him or her.

Warning:

- The unit should not be installed by the user. Ask the dealer or an authorized company to install the unit. If the unit is installed improperly, water leakage, electric shock or fire may result.
- Use only accessories authorized by Mitsubishi Electric and ask your dealer or an authorized company to install them. If accessories are installed improperly, water leakage, electric shock or fire may result.
- The Installation Manual details the suggested installation method. Any structural alteration necessary for installation must comply with local building code requirements.
- Never repair the unit or transfer it to another site by yourself. If repair is performed improperly, water leakage, electric shock or fire may result. If you need to have the unit repaired or moved, consult your dealer.
- The appliance is not intended for use by young children or infirm persons without supervision.
- Young children should be supervised to ensure that they do not play with the appliance.

1) Outdoor unit

Warning:

- The outdoor unit must be installed on a stable, level surface, in a place where there is no accumulation of snow, leaves or rubbish.
- Do not stand on, or place any items on the unit. You may fall down or the item may fall, causing injury.

Caution:

The outdoor unit should be installed in a location where air and noise emitted by the unit will not disturb the neighbours.

2) Indoor unit

Warning:

The indoor unit should be securely installed. If the unit is loosely mounted, it may fall, causing injury.

3) Remote controller

Warning:

The remote controller should be installed in such a way that children cannot play with it.

4) Drain hose

Caution:

Make sure that the drain hose is installed so that drainage can go ahead smoothly. Incorrect installation may result in water leakage, causing damage to furniture.

5) Power line, fuse or circuit breaker

Warning:

- Make sure that the unit is powered by a dedicated line. Other appliances connected to the same line could cause an overload.
- Make sure that there is a main power switch.
- Be sure to adhere to the unit's voltage and fuse or circuit breaker ratings. Never use a piece of wire or a fuse with a higher rating than the one specified.

6) Grounding

Caution:

- The unit must be properly grounded. Never connect the grounding wire to a gas pipe, water pipe, lightning conductor or telephone grounding wire. If the unit is not grounded properly, electric shock may result.
- Check frequently that the ground wire from the outdoor unit is properly connected to both the unit's ground terminal and the grounding electrode.

1.2. During operation

⚠ Caution:

- Do not use any sharp object to push the buttons, as this may damage the remote controller.
- Do not twist or tug on the remote controller cord as this may damage the remote controller and cause malfunction.
- Never remove the upper case of the remote controller. It is dangerous to remove the upper case of the remote controller and touch the printed circuit boards inside. Doing so can result in fire and failure.
- Never wipe the remote controller with benzene, thinner, chemical rags, etc. Doing so can result in discoloration and failure. To remove heavy stains, soak a cloth in neutral detergent mixed with water, wring it out thoroughly, wipe the stains off, and wipe again with a dry cloth.
- Never block or cover the indoor or outdoor unit's intakes or outlets. Tall items of furniture underneath the indoor unit, or bulky items such as large boxes placed close to the outdoor unit will reduce the unit's efficiency.

⚠ Warning:

- Do not splash water over the unit and do not touch the unit with wet hands. An electric shock may result.
- Do not spray combustible gas close to the unit. Fire may result.
- Do not place a gas heater or any other open-flame appliance where it will be exposed to the air discharged from the unit. Incomplete combustion may result.

⚠ Warning:

- Do not remove the front panel or the fan guard from the outdoor unit when it is running. You could be injured if you touch rotating, hot or high-voltage parts.
- Never insert fingers, sticks etc. into the intakes or outlets, otherwise injury may result, since the fan inside the unit rotates at high speed. Exercise particular care when children are present.
- If you detect odd smells, stop using the unit, turn off the power switch and consult your dealer. Otherwise, a breakdown, electric shock or fire may result.
- When you notice exceptionally abnormal noise or vibration, stop operation, turn off the power switch, and contact your dealer.
- Do not over-cool. The most suitable inside temperature is one that is within 5°C of the outside temperature.
- Do not leave handicapped people or infants sitting or standing in the path of the airflow from the air-conditioner. This could cause health problems.

⚠ Caution:

- Do not direct the airflow at plants or caged pets.
- Ventilate the room frequently. If the unit is operated continuously in a closed room for a long period of time, the air will become stale.

2. Names and functions of various parts

Indoor unit

- Air inlet: Sucks the ambient air in.
- Filter: The filter built into the unit as standard is a simple filter to remove visible dust and dirt. If air purification is one of the conditions required for use, consult with your dealer. (For details on how to clean, refer to page 8.)
- Air outlet: Blows the air back out into the room.

PEH-RP-MYA series

[Ceiling concealed type]

[Fig. 2.0.1] (P.2)

- Ⓐ Air outlet Ⓑ Air inlet Ⓒ Air filter

In case of failure

⚠ Warning:

- Never remodel the air conditioner. Consult your dealer for any repair service. Improper repair work can result in water leakage, electric shock, fire, etc.
- If the remote controller displays an error indication, the air conditioner does not run, or there is any abnormality, stop operation and contact your dealer. Leaving the unit as it is under such conditions can result in fire or failure.
- If the power breaker is frequently activated, get in touch with your dealer. Leaving it as it is can result in fire or failure.
- If the refrigeration gas blows out or leaks, stop the operation of the air conditioner, thoroughly ventilate the room, and contact your dealer. Leaving the unit as it is can result in accidents due to oxygen deficiency.

When the air conditioner is not to be used for a long time

- If the air conditioner is not to be used for a long time due to a seasonal change, etc., run it for 4 - 5 hours with the air blowing until the inside is completely dry. Failing to do so can result in the growth of unhygienic, unhealthy mold in scattered areas throughout the room.
- When it is not to be used for an extended time, keep the [power supply] turned OFF.
If the power supply is kept on, several watts or several tens of watts will be wasted. Also, the accumulation of dust, etc., can result in fire.
- Keep the power switched ON for more than 12 hours before starting operation. Do not turn the power supply OFF during seasons of heavy use. Doing so can result in failure.

1.3. Disposing of the unit

⚠ Warning:

When you need to dispose of the unit, consult your dealer. If pipes are removed incorrectly, refrigerant (fluorocarbon gas) may blow out and come into contact with your skin, causing injury. Releasing refrigerant into the atmosphere also damages the environment.

Remote Controller

- Check out your remote controller.
Different controllers are used for different systems.

[Fig. 2.0.2] (P.2)

- Ⓐ Wireless remote controller (option)
Ⓑ Remote controller

3. Operation

Cooling

The air conditioner works to cool the room to the selected temperature.
The fan blows air continuously at the selected speed.

Drying (dehumidifying) : Disabled in the heating mode

The drying mode efficiently reduces the humidity in the room so that the room temperature is not lowered excessively. When the selected room temperature is reached in the Low setting, the airflow will stop for ten minutes and then will resume for three minutes to keep the humidity low.

Heating

- The air conditioner works to heat the room to the selected temperature.
- When selecting the heating mode, a desired room temperature must be set to avoid any cool air. The fan will gradually increase the airflow delivery up to a selected rate.
- When the room temperature reaches the selected temperature and the compressor stops, the fan will deliver a gentle airflow.

Automatic (cooling / heating)

The air conditioner automatically goes into the cooling or heating mode to keep the room at the selected temperature.

Ventilation

- Ventilation will not be displayed when not available (settings cannot be specified).
- When ventilation is selected it will operate in all modes.

Note:



The airflow settings cannot be changed on the main unit.

How to use the wireless remote controller (option)

Replacing the Batteries and how to set the current time

[Fig. 3.0.1] (P.2)

If no signal is transmitted and the indoor unit's lamp does not light up even if the remote controller is operated, the batteries may have run out, so replace them with new ones as described below.

- ① Remove the front lid.
- ② Replace the batteries with alkali batteries (size AAA). Make sure that the batteries are installed in the correct direction. (Insert the minus pole of the batteries first.)
- ③ Reattach the front lid.
- ④ Press the RESET button using a thin stick.
- ⑤ Press the  and  button to set the current time.
- ⑥ Press the CLOCK button using a thin stick and close the front lid.

If you are not going to use the unit for a long period of time, remove the batteries to prevent damage which may occur due to leakage of electrolyte.

Caution:

- Signal from the WIRELESS REMOTE CONTROLLER may not be received by the indoor unit installed in a room with fluorescent lamps using cyclic ignition stabilizer of high voltage pulse or intermittent oscillator. If fluorescent lamps are to be newly installed, consult your local dealer.
- If other air conditioner or electric appliance are effected due to operation of the WIRELESS REMOTE CONTROLLER or vice versa, install the air conditioner at some distance from others or consult your dealer.
- Install the air conditioner in a place free of dust, high temperature, vibration and shock.
- Do not cover the REMOTE CONTROLLER.

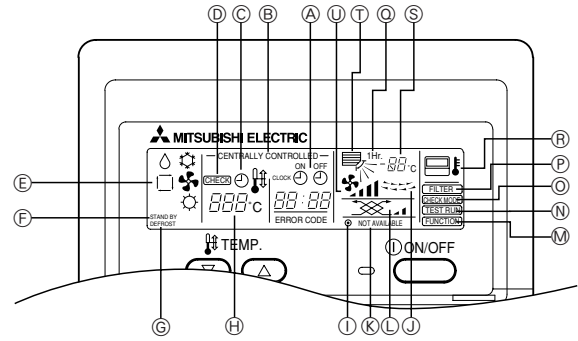
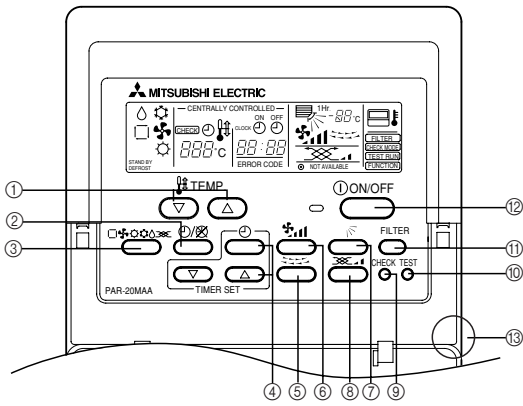

Remote controller-Button

- ① [Room temperature adjustment] Button
 - ② [Timer/continuous] Button
 - ③ [Selecting operation] Button
 - ④ [Time selection] Button
 - ⑤ [Louver] Button
 - ⑥ [Fan speed adjustment] Button
 - ⑦ [Up/down airflow direction] Button
 - ⑧ [Ventilation] Button
 - ⑨ [Checking/built-in] Button
 - ⑩ [Test run] Button
 - ⑪ [Filter] Button
 - ⑫ [ON/OFF] Button
 - ⑬ Position of built-in room temperature
- Never expose the remote controller to direct sunlight. Doing so can result in the erroneous measurement of room temperature.
 - Never place any obstacle around the lower right-hand section of the remote controller. Doing so can result in the erroneous measurement of room temperature.

Remote controller-Display

- A Current time/Timer
- B Centralized control
- C Timer ON
- D Abnormality occurs
- E Operation mode: COOL, DRY, AUTO, FAN, HEAT
- F Preparing for Heating mode
- G Defrost mode
- H Set temperature
- I Power ON
- J Louver
- K Not available function
- L Ventilation
- M Function setting mode
- N Test run mode
- O Error check mode
- P Filter sign
- Q Set effective for 1 hr.
- R Sensor position
- S Room temperature
- T Airflow
- U Fan speed

GB

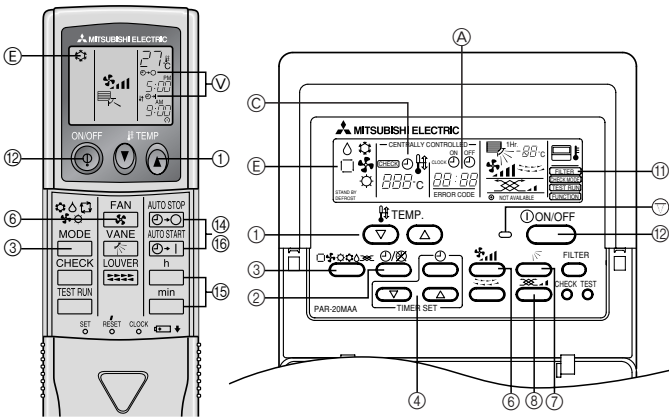

Before starting operation

- Start running after the "HO" display has disappeared. The "HO" display briefly appears on the room temperature display (max. 3 minutes) when the power is turned on and after a power failure. This does not indicate any failure of the air conditioner.
- During heating operation, even if the indoor unit is set to operation while the outdoor unit is in defrosting operation, operation starts after the defrosting operation of the outdoor unit has ended.

3.1. ON/OFF

Start an operation

1. Press the ⑫ [ON/OFF] button
Operation lamp lights up and operation starts.

Stop an operation

1. Press the ⑫ [ON/OFF] button again
Operation lamp goes off and operation stops.
- Once the buttons have been set, pressing of the [ON/OFF] button only can repeat the same operation thereafter.
 - During operation, the operation lamp above the [ON/OFF] button lights up.

⚠ Caution:

Even if the operation button is pressed immediately after the operation is once stopped, operation is not restarted for about 3 minutes. This function protects the machine. It automatically starts operation after the lapse of approximately 3 minutes.

3.2. Selecting operation

When selecting operation

1. Press the ③ [selecting operation] button
Consecutive press of the selecting operation button switches the operation over to , , , (), and (). For the contents of operation, check the display.

For cooling

Press the ③ [selecting operation] button and bring up the display.

For dry

Press the ③ [selecting operation] button and bring up the display.

- Dry operation cannot be carried out at a room temperature of less than 18 °C.

For fan

Press the ③ [selecting operation] button and bring up the display.

- The fan operation functions to circulate the air in the room.
- The temperature of the room cannot be set by fan operation.

⚠ Caution:

Never expose your body directly to cool air for a long time. Excessive exposure to cool air is bad for your health, and should therefore be avoided.

Dry operation

The dry is a microcomputer-controlled dehumidifying operation which controls excessive air-cooling according to the room temperature of your choice. (Not usable for heating.)

1. Until reaching room temperature of your choice

The compressor and indoor fan function is linked motion according to the change of the room temperature and automatically repeat ON/OFF.

2. When reaching room temperature of your choice

Both the compressor and indoor fan stop.

When stop continues for 10 minutes, the compressor and indoor fan are operated for 3 minutes to keep the humidity low.

For heating

Press the ③ [selecting operation] button to bring up the display.

Regarding displays during heating operation "DEFROST"

Displayed only during the defrosting operation.

"STAND BY"

Displayed from the start of heating operation until the moment warm air blows out.

⚠ Caution:

- When the air conditioner is used together with burners, thoroughly ventilate the area. Insufficient ventilation can result in accidents due to oxygen deficiency.
- Never place a burner at a place where it is exposed to the airflow from the air conditioner.
Doing so can result in imperfect combustion of the burner.
- The microcomputer functions in the following cases:
- Air does not blow out when heating starts.
 - To prevent any cool air from escaping.
 - Wait a moment until the airflow comes out naturally.

For ventilation

Press the operation mode (□) button and select the ventilation mode .



Ⓢ  should be displayed.

- Used to provide ventilation without using the heat or air conditioning functions of the unit.
- The  display will not appear when the ventilation equipment is not attached.

3.3. Room temperature adjustment

To change room temperature

Press the  [Room temperature adjustment] button and set the room temperature of your choice.

Pressing  or  once changes the setting by 1 °C. If the pressing is continued, the setting continues to change by 1 °C.

- Indoor temperature can be set within the following range.
 - Cooling/dry: 19 - 30 °C
 - Heating: 17 - 28 °C
- It is impossible to set the room temperature by the air-blow operation.
- * The range of room temperature display is 8 - 39 °C. Outside this range, the display flashes either 8 - 39 °C to inform you if the room temperature is lower or higher than the displayed temperature.

3.4. Fan speed adjustment

Fan speed : 1 stage

Display :  (High)

3.5. Time setting

- Set the current time after turning ON the power of the air conditioner or after restoration from a power failure.
- It can be set regardless of the operation of the indoor unit.
- During the time operation, the time-setting button becomes void, disabling time setting.

1. Press the [Time selection] button and bring up the "Current time/Timer" display



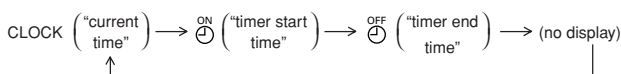







- Every time it is pressed, the display changes.



⚠ Caution:

When the current time is not yet set, the "CLOCK (current time)" display flashes, disabling the setting of timer operation.



2. Set the current time by pressing the or button

- The time cannot be set while the  "Timer on" is displayed.
- While the  "CLOCK" time is displayed, press the time setting   buttons and set the time.
- The setting advances one minute every time the  button is pressed once, and regresses one minute every time the  button is pressed once.
When respective   buttons are pressed continuously, the time display goes forward fast. It advances in the order of 1 minute unit - 10 minute unit - one hour unit.
- About 10 seconds after the button operation has been completed, the  "current time" and  "CLOCK" displays disappear.

⚠ Caution:

- Remote controller is equipped with a simplified clock with a precision of about + or - one minute per month.
- The time must be readjusted (reset) every time the air conditioner is subjected to a power stop of the air conditioner or a power failure.

3.6. Timer setting

- If the timer is set, the unit starts (stops) at the set time, and the time mode is terminated.
- When you wish to confirm the starting and ending time, press the  [Time selection] button while  " " is displayed.

Function of timer

On-timer

Set the on-timer for the time the working day begins in your company. When the set start time arrives, the air conditioner starts operation.

Off-timer

Use the off-timer as a reminder to turn off the air conditioner. When the set end-work time arrives, the air conditioner stops operation.







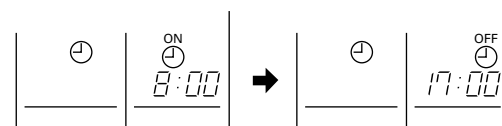







There are three methods for using the timer.





1. ON/OFF Timer: When setting both starting and ending time
2. On-timer: When only setting the starting time
(Ending time is set to " - - : - - ")
3. Off-timer: When only setting the ending time
(Starting time is set to " - - : - - ")

Display example of timer setting



The example shows a timer set for operation start at 8:00 and end at 17:00.



1. Press the  [Timer/continuous] button and bring up the  no display
2. Press the  [Time selection] button and bring up the  "Timer start time" display
3. Press the   button of the  [Time selection] and set the starting time
When using it as an off-timer, set the starting time to " - - : - - ".
The " - - : - - " is displayed next to 23:50.
4. Press the  [Time selection] button and bring up the  "Timer end time" display
5. Press the   button of the [time switch] and set the ending time
When using it as an on-timer, set the ending time to " - - : - - ".
The " - - : - - " is displayed next to 23:50.
6. Press the  [Timer/continuous] button and bring up the  " " display.
Bringing up the  " " display completes the setting

Every time the   button of the  [Time selection] is pressed once, it advances (or regresses) by 10 minutes. If the button is pressed continuously, it advances (or retrogresses) continuously. First set the hour digit and then set the minute digit. When the ON/OFF timer mode is set, you can run (on-timer) or stop (off-timer) operation by pressing the  [ON/OFF] button even when there is remaining time.

Release

Press the  [Timer/continuous] button and disappear the  " " display.

1) Ventilator-Airconditioner combined operation

1. If the unit is off, press the  [ON/OFF] button to turn it on.
 The ON indicator should light up.
- The ventilation equipment will operate automatically when connected to the unit.
2. Press the  button.
 - You can set the ventilation speed at LOW or HIGH.







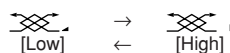

2) Changing the ventilation setting

Press the  button.

- The setting changes each time the button is pushed.



For wireless remote controller (option)

- ⑭ Press the  or  button (TIMER SET).
- Time can be set while the following symbol is blinking.
OFF timer :  is blinking.
ON timer :  is blinking.
 - Use the  and  buttons to set the desired time.
 - Canceling the timer.
To cancel the OFF timer, press the  button.
To cancel the ON timer, press the  button.
 - It is possible to combine both OFF and ON timers.
 - Pressing the ① ON/OFF button of the remote controller during timer mode to stop the unit will cancel the timers.
 - If the current time has not been set, the timer operation cannot be used.

4. The smart way to use

Even minimal steps to care for your air conditioner can help make its use far more effective in terms of air-conditioning effect, electricity charges, etc.

Set the right room temperature

- In cooling operation, a temperature difference of about 5°C between indoors and outdoors is optimum.
- If the room temperature is raised by 1°C during air-cooling operation, about 10% electric power can be saved.
- Excessive cooling is bad for health. It also results in the waste of electric power.

Clean the filter thoroughly

- If the screen of the air filter becomes clogged, the airflow and air-conditioning effect can be significantly reduced. Further, if the condition is left unattended, failure can result. It is particularly important to clean the filter at the beginning of the cooling and heating seasons. (When profuse dust and dirt have accumulated, clean the filter thoroughly.)

5. Caring for the machine

Always have filter maintenance performed by a service person.
Before care-taking, turn the power supply OFF.

⚠ Caution:

- Before you start cleaning, stop operation and turn OFF the power supply. Remember that the fan is rotating inside at high speed, posing a serious risk of injury.
- Indoor units are equipped with filters to remove the dust of sucked-in air. Clean the filters using the methods shown in the following sketches. (The standard filter should normally be cleaned once a week, and the long-life filter at the beginning of each season.)







How to clean

- Clear dust away lightly or clean it up with a vacuum cleaner. In the case of severe staining, wash the filter in lukewarm water mixed with dissolved neutral detergent or water, and then rinse off the detergent completely. After washing, dry it and fix it back into place.

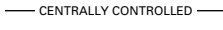
⚠ Caution:

- Do not dry the filter by exposing it to direct sunlight or warming it using fire, etc. Doing so can result in the deformation of the filter.
- Washing it in hot water (more than 50 degree C) can also result in deformation.

3.7. Others

-  : Displayed when control is executed by a separately sold centralized control unit, etc.
-  : Displayed from the start of heating operation until the moment warm air blows out.
-  : This displays indication when some abnormality occurs in the unit.
-  : When a button is pressed for any function which the indoor unit cannot perform, this display flashes concurrently with the display of that function.
-  : In the system in which the "Sensor" display is indicated as the "remote controller", room temperature measurement is performed by the room temperature sensor built into the remote controller. Therefore, pay attention to the following:
: Displayed when it is time to clean the filter.
Press the ① [Filter] button twice, then the display is disappeared.
-  : Displayed when it is time to clean the filter.

Prevent intrusion of heat during air-cooling

- To prevent the intrusion of heat during cooling operation, provide a curtain or a blind on the window to block out direct sunlight. Also, do not open the entrance or exit except in cases of dire necessity.

Carry out ventilation sometimes

- Since the air periodically gets dirty in a room that is kept closed for a long time, ventilation is sometimes necessary. When gas appliances are used together with the air conditioner, special precautions must be taken. If the "LOSSNAY" ventilation unit developed by our company is used, you can perform ventilation with less waste. For details on this unit, consult with your dealer.

⚠ Caution:

Never pour water or flammable sprays onto the air conditioner. Cleaning using these methods can result in the failure of the air conditioner, electric shock, or fire.

Replacement of filter

[Fig. 5.0.1] (P.2)

- Ⓐ Air outlet
- Ⓑ Air inlet
- Ⓒ Air filter
- Ⓓ Air filter handle

- The air filter is located at the air inlet (rear side of the unit).
- Lift the air filter handles and pull the filter towards you.
- If you are going to use an air inlet conduit, remove the air filter. In this case, an air filter must be prepared locally and installed at the intake grille.

6. Troubleshooting

Before you call out a repair man, check the following table to see whether there is a simple solution to your problem.

- **Unit does not cool or heat very well.**
 - Clean the filter. (Dust and debris that collects in the filter will decrease air-flow.)
 - Check the temperature setting and adjust it if necessary.
 - Increase the space surrounding the outdoor unit.
 - Is the air intake or air outlet blocked?
 - Is a window or door open?
- **The unit does not blow air out right away in the heating mode.**
 - The unit is preparing to deliver warm air.
- **The unit stops operating before arriving at the set temperature in the heating mode.**
 - Frost forms when the outdoor temperature is low and humidity is high. Wait for about 10 minutes for the frost to melt.
- **There is a “swishing” noise that occurs from the unit when water flows.**
 - This sound is made when refrigerant inside of the unit is flowing or refilling.
- **A ticking noise is heard from inside of the unit.**
 - This sound is made when internal parts of the unit expand or contract when the temperature changes.
- **An odor is detected in the room.**
 - This is caused when the unit expels odors that have been absorbed from the walls, carpets, furniture or clothing.
- **A white mist is expelled from the indoor unit.**
 - This may occur just after the unit is turned on when a high level of humidity is present in the room.
- **Water or moisture is expelled from the outdoor unit.**
 - This occurs to expel water or moisture that may have collected in the pipes or around piping fixtures.
 - This occurs to dispel water from the heat exchanger.
- **The indicators of the remote controller do not light up when operated.**
 - Turn on the power switch. “ · ” will be displayed.
- **CENTRALLY CONTROLLED is displayed in the remote controller.**
 - The start and stop functions of the remote controller are not available when the CENTRALLY CONTROLLED message is lit.
- **The start and stop functions are not available just after restarting the unit.**
 - Wait about three minutes (operation has stopped to prevent damage to the air conditioner).
- **The unit started even though the start/stop button was not pushed.**
 - Is the timer on?
 - Press the start/stop button to stop the unit.
 - Was a distant command sent from the remote controller?
 - Find out if the remote controller was used.
 - Is the CENTRALLY CONTROLLED message lit?
 - Find out if the remote controller was used.
 - Is the automatic (cooling/heating) mode selected?
 - Press the start/stop button to stop the unit.
- **The unit stopped even though the start/stop button was not pushed.**
 - Is the timer on?
 - Press the start/stop button to restart the unit.
 - Was a distant command sent from the remote controller?
 - Find out if the remote controller was used.
 - Is the CENTRALLY CONTROLLED message lit?
 - Find out if the remote controller was used.
- **The remote controller’s timer cannot be set.**
 - Set the schedule timer if one is connected.
- **“HO” is displayed in the remote controller.**
 - An automatic startup test is being performed (will last for about two minutes).
- **An error code is displayed in the remote controller.**
 - A self-diagnostic function is being performed to preserve the air conditioner.
 - * Do not attempt to make repairs yourself. Turn the main switch off and contact the dealer from whom you bought the air conditioner. Provide him or her with the name of the unit and the information displayed in the remote controller.
- **No display appears on the wireless remote controller. Signals are not received by the thin sensor unless sent from close up.**
 - The batteries are becoming weak.
 - Replace the batteries and press the reset button.
 - * If the display does not appear after replacing the batteries, make sure that the (+, -) cells are aligned correctly.
- **The operating display of the wireless remote controller’s receiver is flashing.**
 - A self-diagnostic function is being performed to preserve the air conditioner.
 - * Do not attempt to make repairs yourself. Turn the main switch off and contact the dealer from whom you bought the air conditioner. Provide him or her with the name of the unit.
- **The fan in the indoor unit does not operate.**
 - Check the over-current relay on the fan motor to determine whether it has been tripped.
 - If the over-current relay has been tripped, reset it after eliminating the cause of the problem (e.g. motor lock).
 - To reset the over-current relay, open the control box and press the green claw on bottom-right of the relay until a click is heard. Release the claw and check that it returns to its original position.
 - Note that if it is pressed too hard it will not return to its original position.

7. Troubleshooting [for wireless remote controller (option)]

Before you call out a repair man, check the following table to see whether there is a simple solution to your problem.

Problem	Solution	Problem	Solution
Unit does not operate at all.	Turn main power on. Then press the POWER ON/OFF button to turn the unit on. Wait until power is restored, then press the POWER ON/OFF button to turn the unit on.	Unit does not start immediately.	Wait until the unit restarts automatically. The compressor may hesitate resuming because a three-minute resume prevention circuit is incorporated in the outdoor unit for protection of the compressor.

NOTE: After a power cut, the unit will not restart automatically. You will have to restart it by pressing the POWER - ON/OFF button on the remote controller.

If none of the above apply, turn the main switch off and contact the dealer from whom you bought the air-conditioner, telling him the model name and the nature of the problem. Do not try to fix the unit yourself.

In any of the following cases, turn off the main power switch and contact your local dealer for service:

- The operation lamp (on the main unit) flashes.
- The switches do not work properly.
- The circuit breaker trips frequently (or the fuse blows frequently).
- Water has accidentally been splashed into the unit.
- Water leaks from the unit.
- Something is accidentally dropped into the air-conditioner.
- An unusual noise is heard during operation.

The following do not indicate any malfunction:

Odours: smells such as tobacco or cosmetic odours may persist after they have been sucked into the unit.

Sound of liquid flowing inside indoor unit: this can occur during or after operation and is simply the sound of refrigerant being circulated inside the unit.

Ticking sound coming from indoor unit: this can occur when cooling or heating has just begun or has just stopped. It is caused by the indoor unit shrinking or expanding slightly due to the change in temperature.

The message “CENTRALLY CONTROLLED” appearing on the LCD panel: from time to time, this message may come up on the LCD panel. This does not indicate any malfunction.

8. Installation and transferring works, and checking

Regarding place for installation

Consult with your dealer for details on installation and transferring the installation.

⚠ Caution:

Never install the air conditioner where there is a risk of leakage of flammable gas.

If gas leaks and accumulates around the unit, fire can result.

Never install the air conditioner at the following place:

- where there is much machine oil
- near ocean and beach areas where there is much salt
- where humidity is high
- where there are hot springs nearby
- where there is much sulfureted gas
- where there is a high-frequency processing machinery (a high-frequency welder, etc.)
- where acid solution is frequently used
- where special sprays are frequently used
- Install the indoor unit horizontally. Otherwise, water leakage can result.
- Take sufficient measures against noise when installing the air conditioners at hospitals or communication-related businesses.

If the air conditioner is used in any of the above-mentioned environments, frequent operational failure can be expected. It is advisable to avoid these types of installation sites.

For further details, consult with your dealer.

Regarding electrical work

⚠ Caution:

- **The electrical work must be undertaken by a person who is qualified as an electric engineer according to the [technical standard respecting electrical installation], [internal wiring rules], and the installation instruction manual with the absolute use of exclusive circuits. The use of other products with the power source can result in burnt-out breakers and fuses.**
- **Never connect the grounding wire to a gas pipe, water pipe, arrester, or telephone grounding wire. For details, consult with your dealer.**
- **In some types of installation sites, the installation of an earth leakage breaker is mandatory. For details, consult with your dealer.**

Regarding transfer of installation

- When removing and reinstalling the air conditioner when you enlarge your home, remodel, or move, consult with your dealer in advance to ascertain the cost of the professional engineering work required for transferring the installation.

⚠ Caution:

When moving or reinstalling the air conditioner, consult with your dealer. Defective installation can result in electric shock, fire, etc.

Regarding noise

- In installing work, choose a place that can fully bear the weight of the air conditioner, and where noise and vibration can be reduced.
- Choose a place where cool or warm air and noise from the outdoor air outlet of the air conditioner do not inconvenience the neighbors.
- If any alien object is placed near the outdoor air outlet of the air conditioner, decreased performance and increased noise can result. Avoid placing any obstacles adjacent to the air outlet.
- If the air conditioner produces any abnormal sound, consult with your dealer.

Maintenance and inspection

- If the air conditioner is used throughout several seasons, the insides can get dirty, reducing the performance.

Depending upon the conditions of usage, foul odors can be generated and drainage can deteriorate due to dust and dirt, etc.

9. Specifications

PEH-RP-MYA SERIES

Item	Model	PEH-RP8MYA	PEH-RP10MYA
Power source	Voltage	3N~ V	380, 400, 415
	Frequency	Hz	50
Cooling capacity*1	kW	19.0	22.0
	kcal/h	16,300	18,900
Heating capacity*1	kW	22.4	27.0
	kcal/h	19,300	23,200
Dimension	Height	mm	428
	Width	mm	1,380
	Depth	mm	650
Net weight	kg	70	80
Fan	Airflow rate	m ³ /min	60
	External static pressure*2	Pa	50 <150>
Noise level	dB(A)	49	53

Notes: *1 Refer to the product nameplate attached to the unit for the electrical specifications.

*2 Rating conditions (cooling) Indoor: 27°C DB, 19°C WB Outdoor: 35°C DB

*3 Rating conditions (heating) Indoor: 20°C DB Outdoor: 7°C DB, 6°C WB

Operating range

		Indoor air intake temperature	Outdoor air intake temperature
Cooling	Maximum	35°C DB, 22.5°C WB	46°C DB
	Minimum	19°C DB, 15°C WB	-5°C DB
Heating	Maximum	28°C DB	21°C DB, 15°C WB
	Minimum	17°C DB	-11°C DB, -12°C WB

Units should be installed by licensed electric contractor accordingly to local code requirement.

This product is designed and intended for use in the residential, commercial and light-industrial environment.

The product at hand is based on the following EU regulations:

- Low Voltage Directive 73/23/EEC
- Electromagnetic Compatibility Directive 89/336/EEC

Please be sure to put the contact address/telephone number on this manual before handing it to the customer.